

Syphon for pressure measuring instruments

Model 910.15

WIKA data sheet AC 09.06

Applications

- Syphons protect pressure measuring instruments from pulsations in the medium and from excessive heating
- Cooling element for fluids, gases and vapours in pressure measurement
- For direct mounting to the pressure connection of the pressure measuring instrument or to the shut-off device (stopcock or valve) mounted underneath

Special features

- Designs per DIN 16282 or to industrial standards
- Permissible temperatures to 400 °C
- Nominal pressures to 160 bar
- Materials: Steel (1.0039, 1.0345) and stainless steel (1.4571)

Description

Syphons per DIN 16282 U-form, form B, and trumpet form, form D, have a welding connection for the pressure tapping on the process side and a threaded connection on the instrument side.

In the industrial standard versions, threaded connections are also available for the pressure tapping on the process side.

U-form syphons are intended for horizontal pressure tapping; trumpet-form syphons are intended for vertical pressure tapping.

Inside the syphon, condensate is collected, which prevents the ingress of hot media into the measuring instrument. We recommend filling the syphon with a cooling separating liquid before commissioning the pressure line.



Syphons, DIN 16282, stainless steel

Fig. left: U-form, form B

Fig. right: Trumpet form, form D

Operating limits

Material	Permissible operating temperature up to °C	Max. working pressure ¹⁾ in bar
Steel 1.0039, 1.0345	120	160
	300	120
	400	104
Stainless steel 1.4571	120	160
	300	140
	400	131



¹⁾ With some industrial standard syphons the maximum working pressure is limited to 25 bar, see table on page 3

Options

- Other connection threads
- Special pipe for high temperatures and working pressures
- Material: Monel
- 1.4571 stainless steel, oil and grease-free for oxygen service
- 3.1 / 3.2 material test certificate
- Pipe connectors for pressure measuring instruments, see page 3

1. Versions per DIN 16282

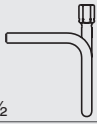
With welding connection on the pressure tapping side

Design	Material	Order no.	
U-form, form B 	1.0345	9091190	
	1.0345 with 3.1	2057876	
	Outlet ²⁾ :	1.4571	1323270
	LH/RH union G 1/2	1.4571 with 3.1	2194023
Trumpet form, form D 	1.0345	9091211	
	1.0345 with 3.1	1614940	
	Outlet ²⁾ :	1.4571	1440497
	LH/RH union G 1/2	1.4571 with 3.1	1614924

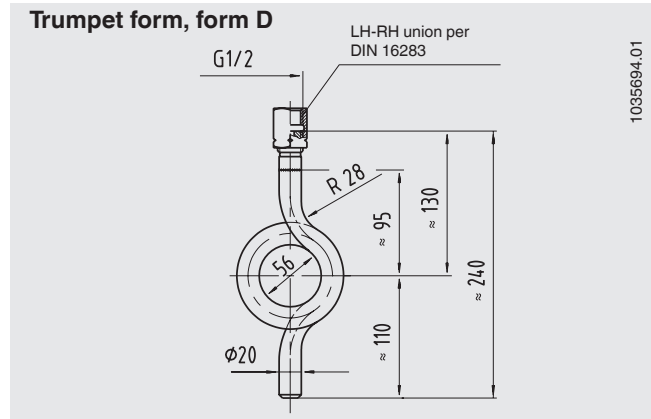
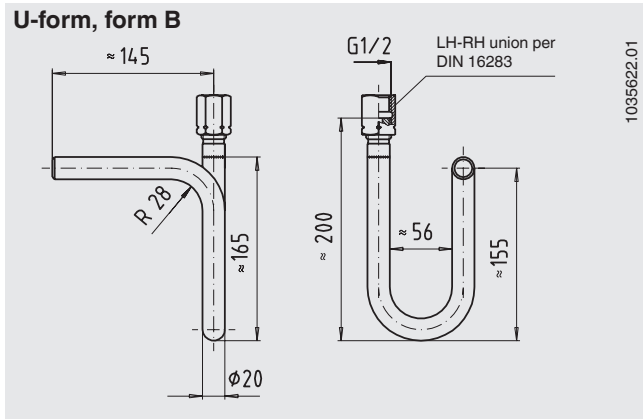

2) Instrument side

Dimensions in mm

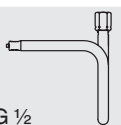

2. Industrial standard designs (similar to DIN 16282)

With G 1/2 B threaded connection on the pressure tapping side



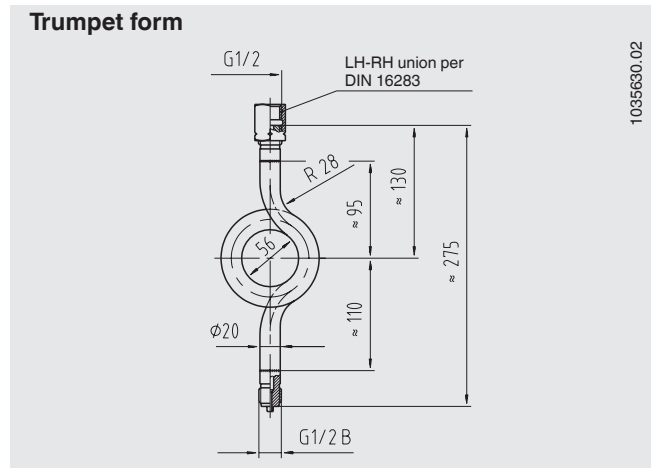
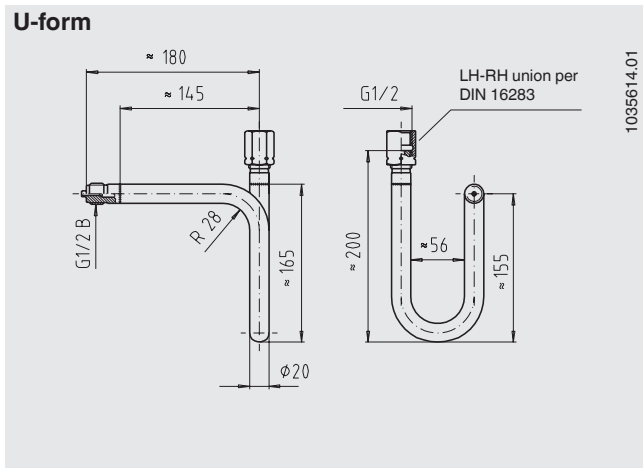

Design	Material	Order no.	
U-form 	1.0345	9091181	
	1.0345 with 3.1	on request	
	Outlet ²⁾ :	1.4571	9091220
	LH/RH union G 1/2	1.4571 with 3.1	2057841
Trumpet form 	1.0345	9091203	
	1.0345 with 3.1	2329039	
	Outlet ²⁾ :	1.4571	9091238
	LH/RH union G 1/2	1.4571 with 3.1	1323997
	1.4571 with 3.1 NACE	2105449	

2) Instrument side

Dimensions in mm



3. Industrial standard designs

Design	Connection thread G	Max. working pressure	Material	Dimensions in mm							Order no.
				D	h	h ₁	l	u	s		
U-form 	G 1/2 B ⁴⁾	25 bar	1.0039	-	170	130	225	60	13	9090649	
	G 1/2 B ⁴⁾	25 bar	1.0345	-	170	130	225	56	20	9090657	
Inlet ¹⁾ and Outlet ²⁾ : Male thread											
U-form 	G 1/2 B ⁴⁾	25 bar	1.0345	-	205	130	225	56	20	9090665	
	G 1/2 B ⁵⁾	see table on p. 1	1.0345	-	200	130	225	56	20	9090673	
Inlet ¹⁾ : G 1/2 B Outlet ²⁾ : LH/RH union G 1/2											
U-form 	G 1/2 B	see table on p. 1	1.0345	-	200	130	-	56	-	9090681	
Inlet ¹⁾ : without thread ³⁾ Outlet ²⁾ : LH/RH union G 1/2											
Trumpet form 	G 1/2 B ⁴⁾	25 bar	1.0039	60	240	120	-	-	13	9090592	
	G 1/2 B ⁴⁾	25 bar	1.0345	56	230	115	-	-	20	9090606	
Inlet ¹⁾ and Outlet ²⁾ : Male thread											

- 1) Process side
- 2) Instrument side
- 3) Prepared for welding
- 4) Thread machined directly onto pipe
- 5) Welded pressure connection

Dimensions in mm

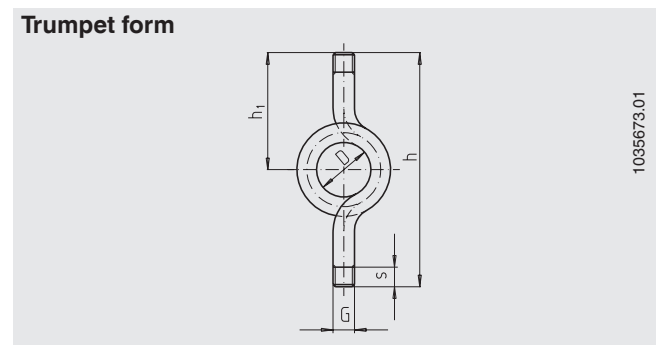
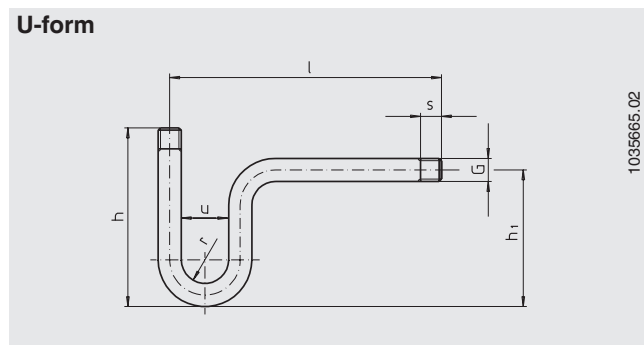

4. Pipe connectors for pressure measuring instruments

Welding connection on the pressure tapping side (outlet ²⁾: LH/RH union G 1/2

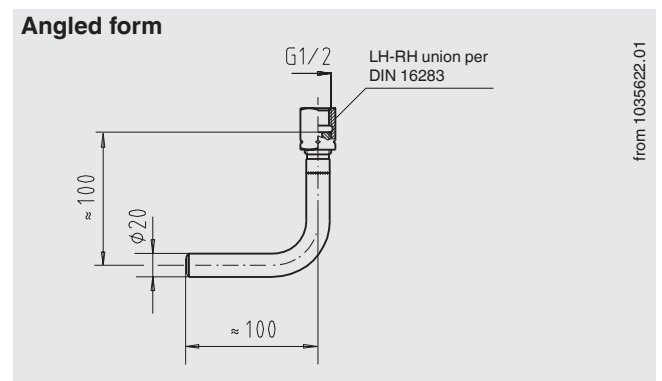
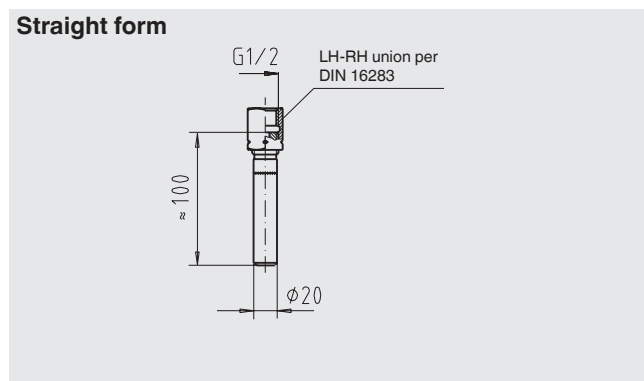

Design	Material	Order no.
Straight form	1.0345	2243679
	1.4571	2112892

Design	Material	Order no.
Angled form	1.0345	2243687
	1.4571	2003612

Ordering information

To order the described product, the 7-digit order number is sufficient. Other options require additional specification.

© 2007 WIKA Alexander Wiegand SE & Co. KG, all rights reserved.
The specifications given in this document represent the state of engineering at the time of publishing.
We reserve the right to make modifications to the specifications and materials.



WIKAL Alexander Wiegand SE & Co. KG
Alexander-Wiegand-Straße 30
63911 Klingenberg/Germany
Tel. (+49) 9372/132-0
Fax (+49) 9372/132-406
E-mail info@wika.de
www.wika.de